



INSTALLATION AND USER MANUAL

ECOHEAT TD

EH160TD

EH200TD

EH260TD





1.	INTRODUCTION	1
2.	GENERAL INDICATIONS	1
3.	TECHNICAL INFORMATION	3
4.	INSTALLATION STEPS	7
5.	THERMODYNAMIC SOLAR PANEL INSTALLATION	8
6.	PLACING ECOHEAT	10
7.	CONNECTION BETWEEN ECOHEAT TD AND PANELS	11
8.	HIDRAULIC CONNECTION	13
9.	ELECTRICAL CONNECTION	14
10.	COMISSIONING. CONTROLLER	15
11.	WARRANTY CONDITIONS	25



1. INTRODUCTION

Thank you for buying a product manufactured by CLIMER TECHNOLOGY. This product, has been manufactured according to the European Quality Standards, incorporates prime grade materials and its correct working has been tested before it leaves our facilities.

Through this Installation and User Manual, you will be guide towards the correct and safety installation of the product. It is necessary to carefully read this manual before making any handling to avoid problems arising from the misuse of the product.

The company CLIMER TECHNOLOGY reserves the right to modify the information included in this document at any time without prior notice.

2. GENERAL INDICATIONS

2.1. Safety notes

The incorrect or inappropriate use of this product could lead to hazardous situations, causing damage or injuries to the user, third parties or even to the product itself or material goods.

- The installer has the responsibility to install the minimum safety devices (hydraulic and electrical) set out in this Manual. In case of failure, the lack of any device may cause burns or other injuries.
- The installer has the responsibility to inform the user about the function and placement of the safety devices installed into the device and the installation.
- The water outlet temperature could reach 62 degrees. Do not touch the pipes while the system is working to avoid any risk of burns.

2.2. Installer's qualification

Since the installation of the ECOHEAT TD involves handling coolant as well as carry out welding work, it is needed the technical staff have the official certification that accredits them as authorized to handle coolants.

The installer must explain the user the application of the product and the use and management of the unit, and he should provide the user all the documentation supplied with the equipment.



2.3. Package contents

The ECOHEAT system comprises the following components:

- Thermodynamic panel
- Anchoring elements
- ECOHEAT TD
- Silent-Blocks
- User Manual

2.4. Indications about transport and unpacking the unit

The unit is supplied packed into a wooden pallet properly secured to prevent damage during transport.

The material that CLIMER TECHNOLOGY uses to the packing are recyclables, so dispose it in an appropriate container.

Use a forklift or hand pallet truck to transport the unit to the installation site, always introducing the forks into the bottom of the pallet being careful not to damage the unit.

In case you identify any damage at the time of the reception of the unit, it is mandatory to register it in the reception note of the transport company, and then, submit the complaint.

For this reason, it is recommended to make a thorough visual inspection of the goods before signing the reception note.



3. TECHNICAL INFORMATION

3.1. Operating Principle

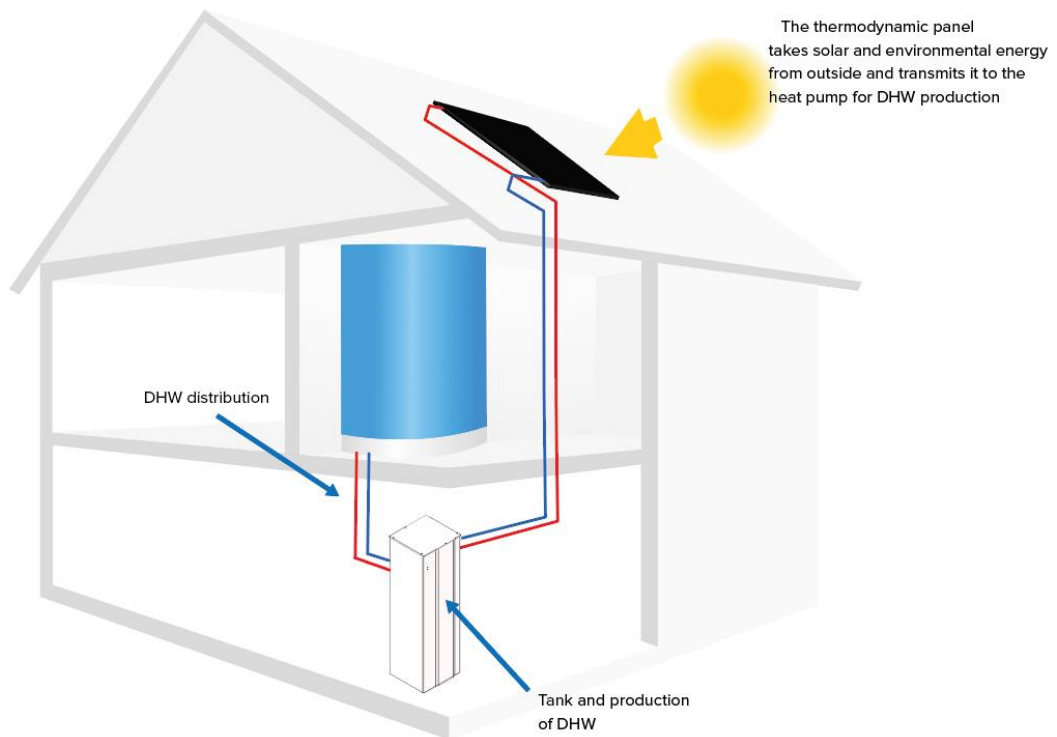
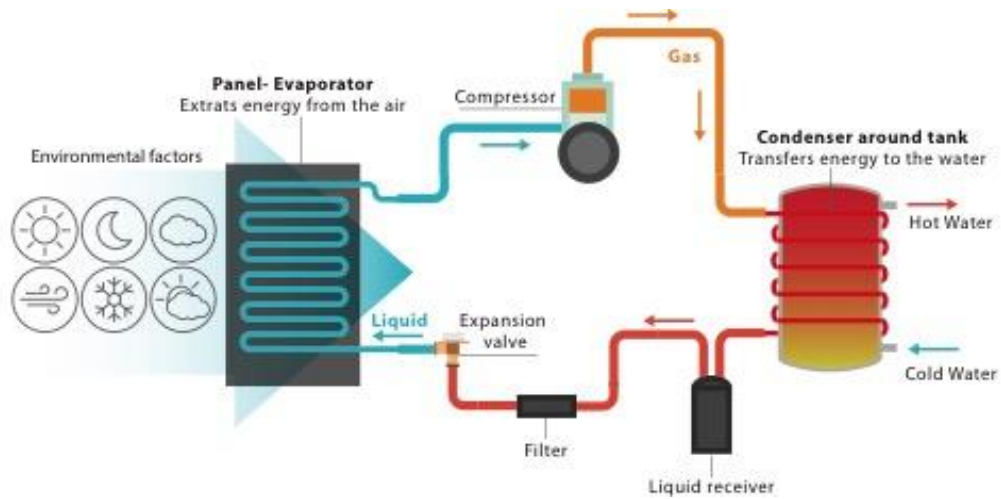

The thermodynamic panel takes solar and environmental energy from outside and transmits it to the heat pump for DHW production



3.2. Dimension drawings

It is possible to remove the side and front casing access easily to any part of the system.

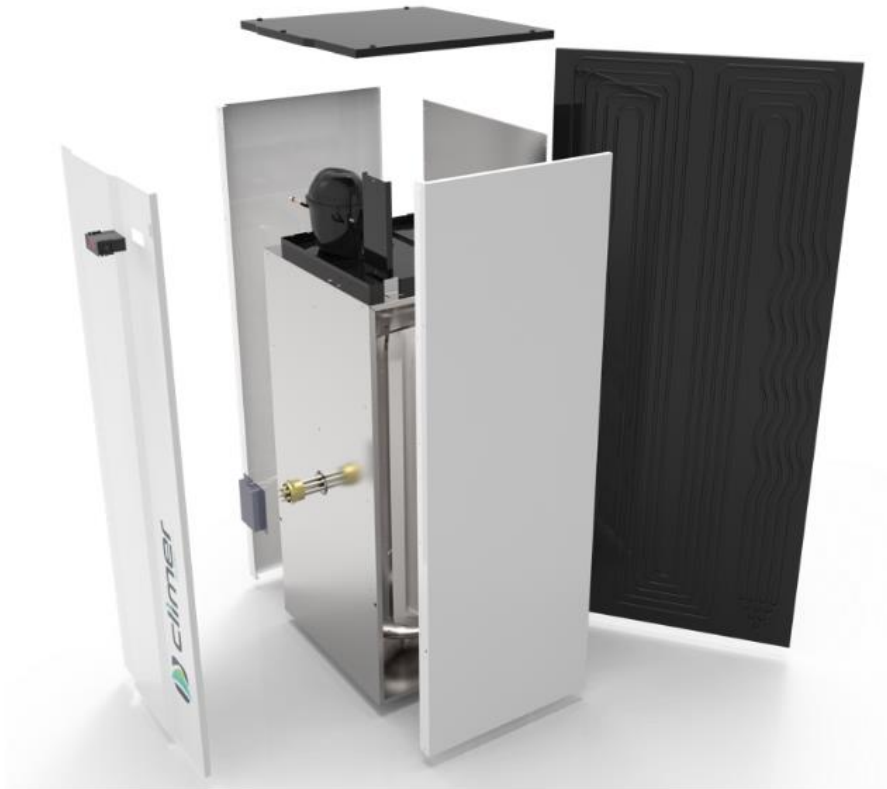



				Dimensions, mm		
				EH160	EH200	EH260
A	585	585	585			
B	587	587	587			
C	1297	1527	1945			
D	727	956	1323			
E	217	217	217			
F	94	194	194			

Back connections		Front connections	
F	Refrigerant inlet, 3/8 inch	J	Hot water outlet, 3/4 inch
G	Refrigerant outlet (liquid), 1/4 inch	K	Cold water inlet, 3/4 inch
H	Power supply, 230 V/1 PH/50 Hz	L	Recirculation connection, 3/4 inch
I	Condensate drain	M	Electrical heater / Temperature probe



3.3. Technical data

Model	EH160 TD	EH200 TD	EH260 TD
Cylinder			
Capacity, L	160	200	260
Maximum operating pressure, bar	6		
Heat pump data			
Energy Efficiency Class	A		
Load profile	L		XL
Heating capacity range *, W	1430 – 2560		
Input power range *, W	450 – 540		
Maximum temp. HP, °C	60		
Maximum temp. electric element, °C	62		
Coolant	R134A		
Electric data			
Power supply, V/ph/Hz	230/1/50		
Electric element power, W	1500		
Maximum current, A	10,1		
Maximum power absorbed, W	2100		
Thermodynamic panel			
Number of panels	1		
Dimensions, mm	1700 x 800		
Maximum operating pressure, bar	10		
Refrigerant inlet/outlet, inch	1/4 - 3/8		

Thermodynamic panel dimensions:

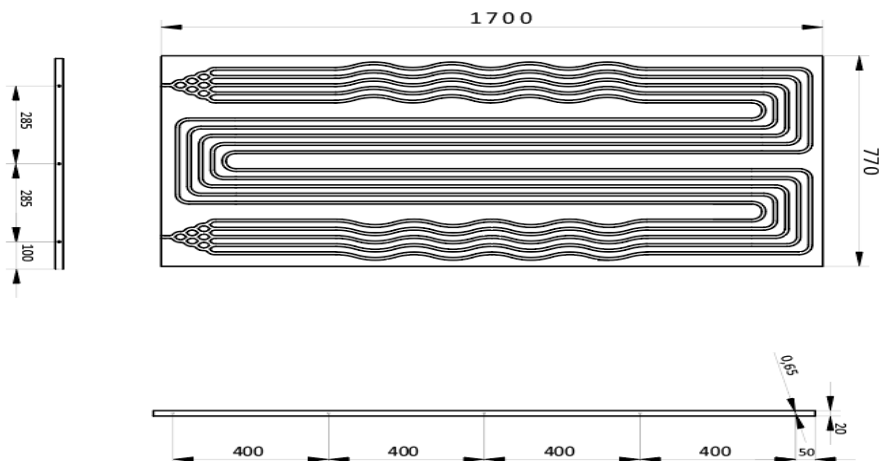



4. INSTALLATION STEPS

Before starting the installation, check the availability of all the necessary components and tools:

- High and low pressure manometers
- Vacuum pump
- Scales
- Nitrogen bottle
- Refrigerant quality copper pipe
- Pipe-cutter
- Tube bender
- Pipe expander
- Welder
- Copper Rods (40 % silver)
- Insulating hose
- Drill
- Screwdriver
- Hydraulic installation components
- Electric installation components

Once it has been checked that it is available all the necessary components and tools, the installer should follow the next steps:

1. Placing and anchoring panels
2. Joining and welding the refrigerant pipes
3. Placing the ECOHEAT TD
4. Joining and welding liquid and suction line between ECOHEAT TD and panel
5. Nitrogen pressure test (maximum 10 bar)
6. Vacuum
7. Filling refrigerant installation
8. Hydraulic installation
9. Electric installation
10. Commissioning
11. Adjustment of refrigerant load



5. THERMODYNAMIC SOLAR PANEL INSTALLATION

5.1. Site selection

The choice of the installation site of the thermodynamic panel is a key factor in the final performance of the unit. For this reason, we recommend following the indications in order to achieve the best performance:

- South orientation is indeed the best to take the maximum advantage of solar radiation. Panel may also have other orientations, but northerly orientation is the worst to receive solar radiation.
- Inclination: The minimum inclination of the panel is 45° in order to ensure the correct evaporation of the coolant. It is recommended to install the panel with an inclination between 45° and 90° . The minimum inclination of the panel must be 5° to ensure the correct evaporation of the fluid.
- Direction: The panel can be installed in a vertical or horizontal position. In the case of horizontal installation, the refrigerant inlet will be made through the lower part of the panel.
- Distance to the equipment: The maximum distance allowed from the panels to the equipment is 15 meters (sum of the distances $L1 + L2 + L3 + L4$ in the following figure).

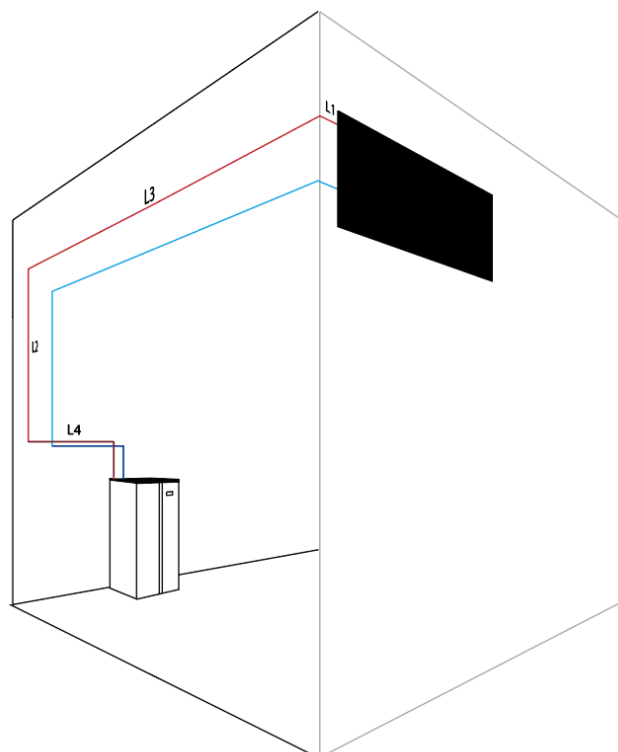

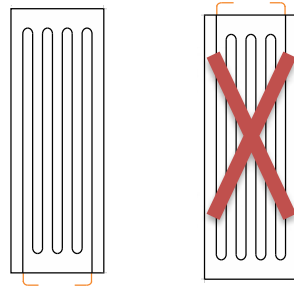

When the panel is installed in vertical position, always the inlet and outlet connection has been at the bottom. (It is not allowed to install the reverse)

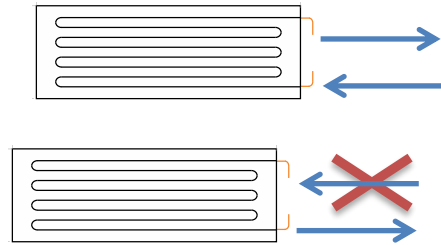

If the panel is installed at horizontal position, refrigerant inlet pipe should be connected into the bottom connection.

5.2. Anchoring panel

Beside the panel, it is supplied a bag with anchoring elements that contains the following pieces:

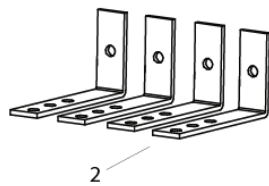
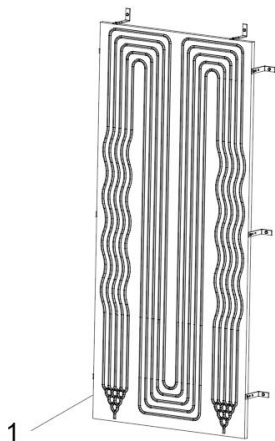

	Ref.	Qty.
Panel	1	1
Aluminium support (L shape)	2	6
Screw M5	3	6
Nut M5	5	6
Washer 5	4	12
Sheet metal screw	6	6
Block M6	7	6

Anchor the panels using the lateral and front holes to the suitable surface.

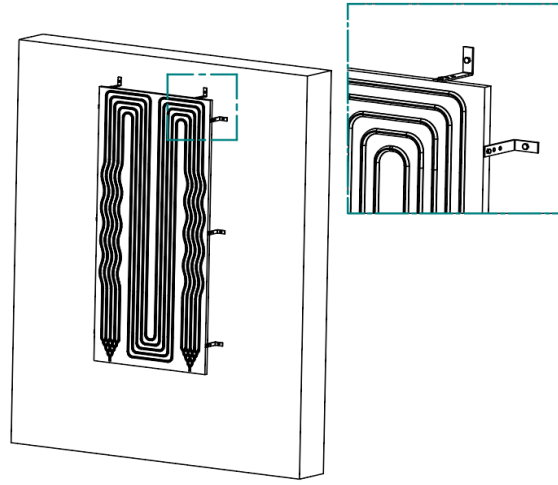

6. PLACING ECOHEAT

The place where the system will be installed should allow an easy access in order to make maintenance work or inspection.

Air outlet of ECOHEAT is around 5-10 degrees below inlet temperature, so in case that the exhaust air would not be ducted, the room temperature will be considerably reduced.

Beside these factors, it is important to take into account the following indications regards the installation site:

- The system has been designed and manufactured for it indoors utilization. Install the system in a dry, frost-free room at a minimum temperature of 5 °C.
- Installer must install the supplied Silent blocks to avoid the transmission of vibration.



7. CONNECTION BETWEEN ECOHEAT TD AND PANELS

a. Pipeline installation

First, measure the distance between Ecoheat and Panels and cut the appropriate copper pipe length. The diameter for each line is:

- Liquid line: 1/4 inch
- Gas line: 3/8 inch

b. Join refrigerant pipes to the Panels and Ecoheat

Panels are supplied with two nuts for the inlet and outlet connection. The inlet to each panel is 1/4 inch diameter. The installer has to insert the nut into the copper pipe, flare the pipe and then use the nut to fit it.

Repeat the procedure with the outlet connection using 3/8 inch copper pipe.

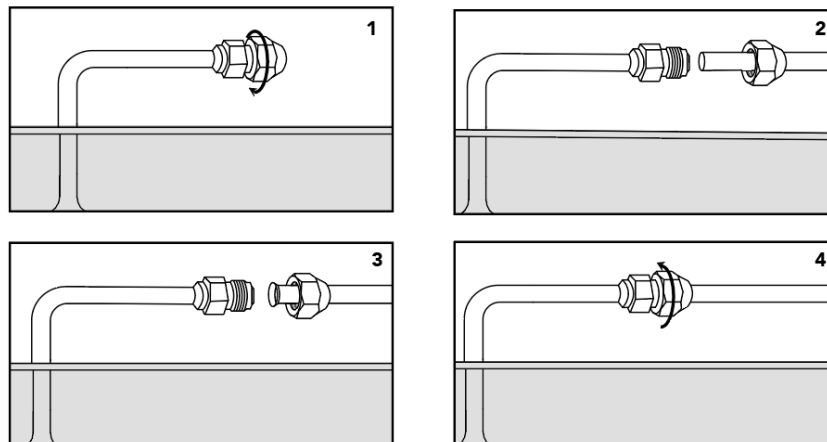

Then, join the suction line that comes from the panel to the coolant inlet of ECOHEAT, and the liquid line to the coolant outlet. The connections are threaded, if welding is needed, weld by oxyacetylene welding.

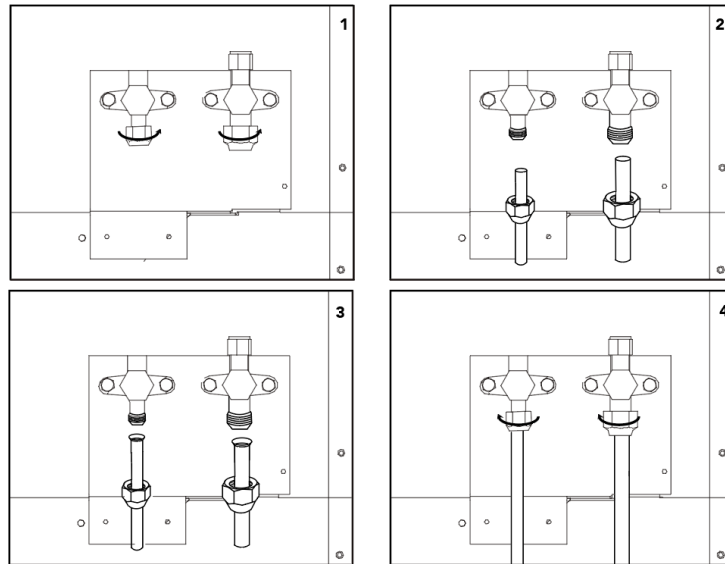

IMPORTANT (Only when welding is needed):

It is recommended to weld pipelines by oxyacetylene welding.

Welding is a critical step in the installation and to do it well ensures that the system will run properly along its useful life.

Only expert staff should make this step by using proper tools and high-quality materials.

c. Nitrogen test and cleaning procedure

In order to check the tightness, introduce nitrogen by using the pressure gauge already installed into load ports.

CAUTION: Never exceed a nitrogen load greater than 10 bars.

Use leaking detector fluid at every welding and even in panel's connections to verify the absence of leaks.

d. Vacuum

Connect the vacuum pipe to the pressure gauge to carry out a vacuum of the whole installation.

e. Coolant filling

Open the load ports to fill the circuit with the refrigerant loaded into the system.



8. HIDRAULIC CONNECTION

The hydraulic connections are shown in the following scheme:

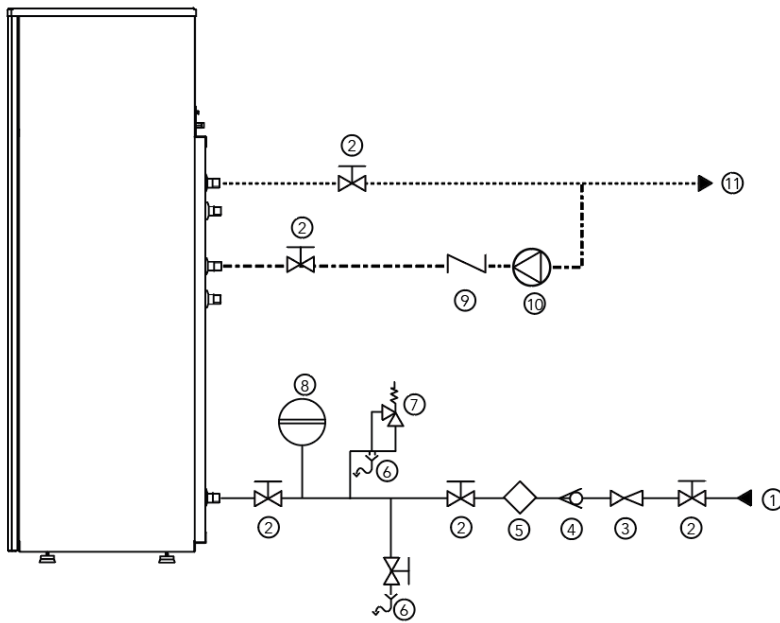

The installer must install the following components of the hydraulic circuit:

- Cold water inlet (1)
- Ball valves (2)
- Pressure reducing valve (3)
- Non- return valve (4)
- Lined Filter Strainer (Y Type) (5)
- Drain (6)
- Safety valve (7)
- Expansion vessel (8)
- Check valve (9)
- Recirculation pump (10)
- DHW (11)

Once the hydraulic connections are made, vent the circuit to avoid the air inside the installation.



9. ELECTRICAL CONNECTION

The power supply of the system is 230 V/1/50 Hz. The power supply line must be protected with a 16 A circuit breaker. The electrical scheme is shown in the picture below:

- PV: Photovoltaic connection
- LPS: Low pressure switch
- HPS: High pressure switch
- NTC1: Water temperature probe
- NTC2: Ambient temperature probe
- D: Display
- VS: Solenoid valve
- R: Electrical heater
- K: Compressor
- F: Fan
- 230 VAC: Power supply

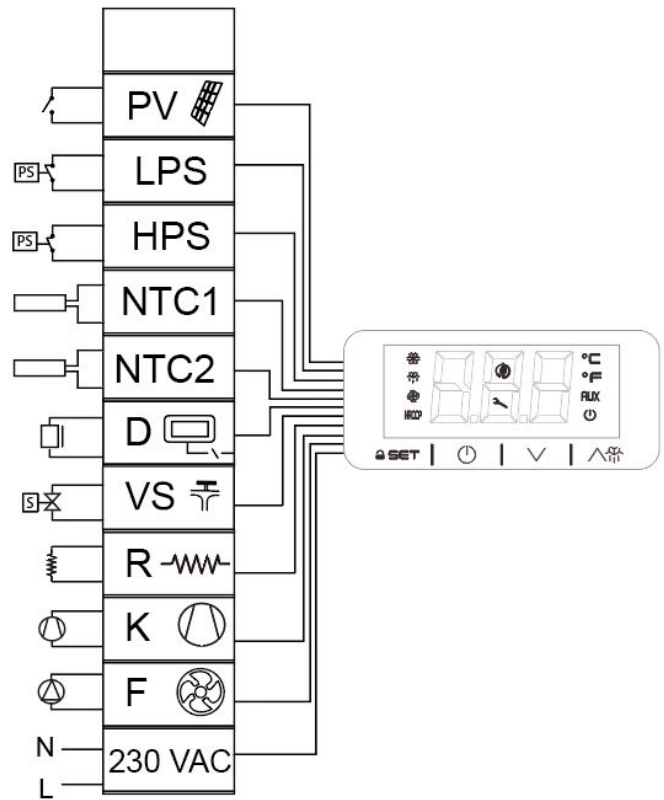



10. COMMISSIONING. CONTROLLER.

10.1. USER INTERFACE DESCRIPTION

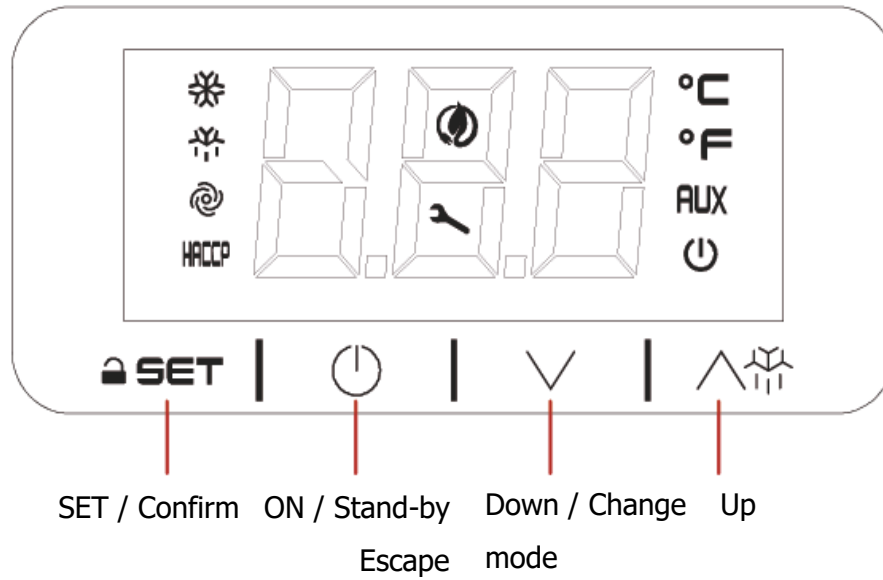

Symbol	Meaning when it lights
	Compressor switched on
	Defrost active
	Fan switched on
	Alarm active
	Compressor working hours exceeded
	Unit in °C
	Unit in °F
	Electric heater switched on
	Stand by



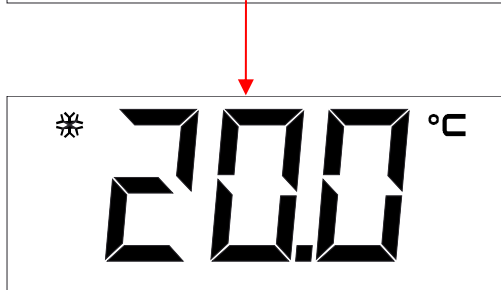
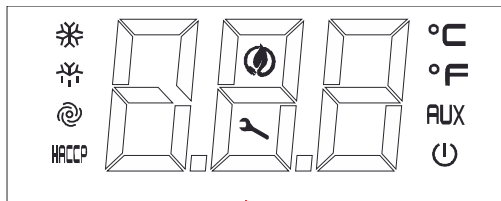
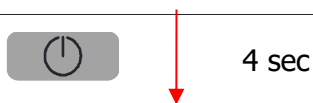
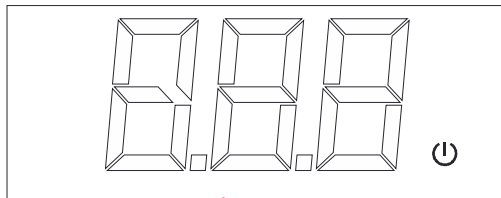

10.2. INSTALLATION- Switching on

After full installation of the water heater (power and water pipes connected) and after the water heater tank is full of water, power can be turn ON.



1. After filling the tank of water, connect the mains plug to the mains supply.

The screen will show the  symbol

2. Hold the  key for 4 seconds. The display will show the icons.

3. The screen will show the water temperature

10.3. Switching OFF

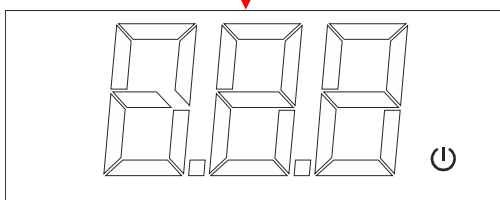

To switch off the system, hold the

 key for 4 seconds



10.4. Unlocking the keypad

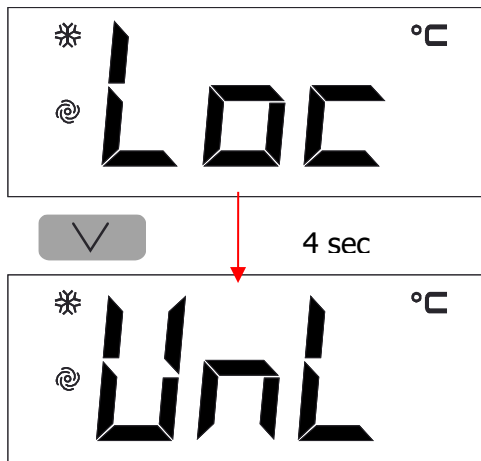

When 30 have elapsed without the keys being pressed, the display will show the " LOC" label and the keypad will lock automatically

Touch any key until the screen shows UnL, to unlock the keypad

10.5. Displaying the operating mode

At first initial power ON, the product goes, by default, in Eco mode. By touching one time the  key, the controller will show the mode in operation in this moment.

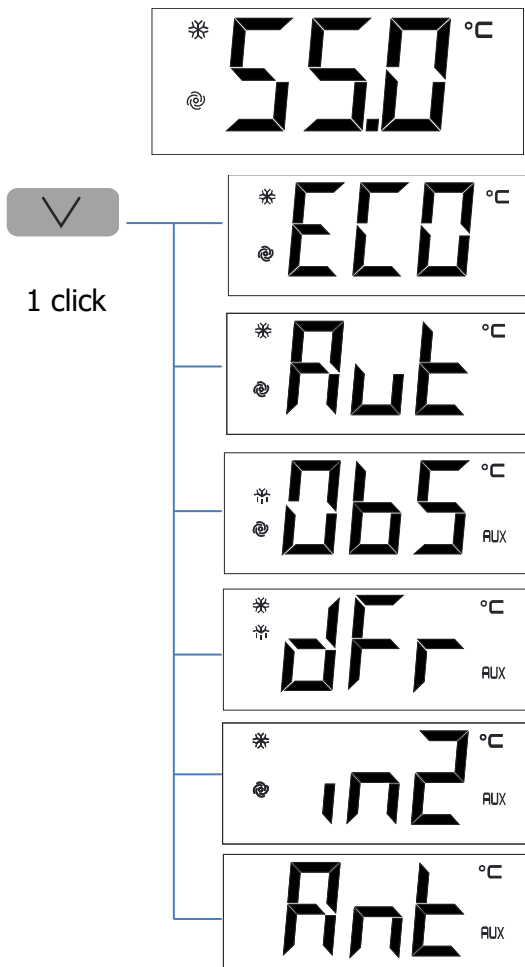

ECO Mode: Heating only by heat pump technology

Auto Mode: Heating by heat pump and electric heater only if the water temperature falls drastically

OverBoost Mode: Simultaneously heating by heat pump and electrical heater to achieve the temperature setpoint

Defrost: Defrost cycle active

Photovoltaics/ Timer: Automatic working due to the existence of surplus energy from PV installation or Off-Peak Rate



Antilegionella: Automatic disinfection by thermal shock

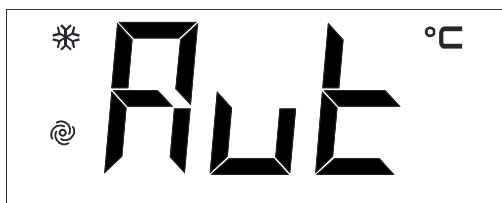
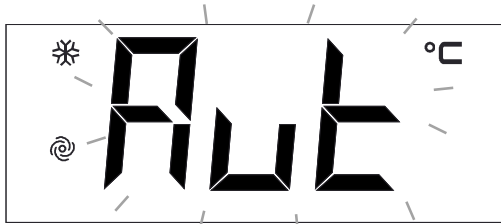
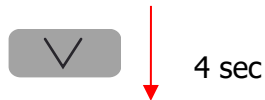

10.6. Changing operating mode



To change the operating mode, touch the  key for 4 seconds.

The screen will show blinking the selectable operating modes. Use the  and  keys to select the operating mode.

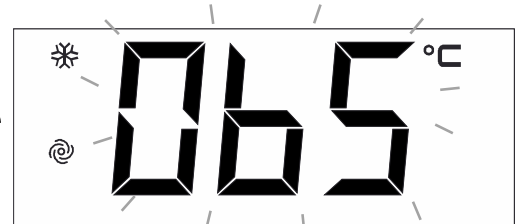

Touch  to confirm or  to cancel

The screen will show again the water temperature



10.7. ECO Mode



ECO mode: Maximum savings. The system heats water only by heat pump technology.

This is the factory default mode.

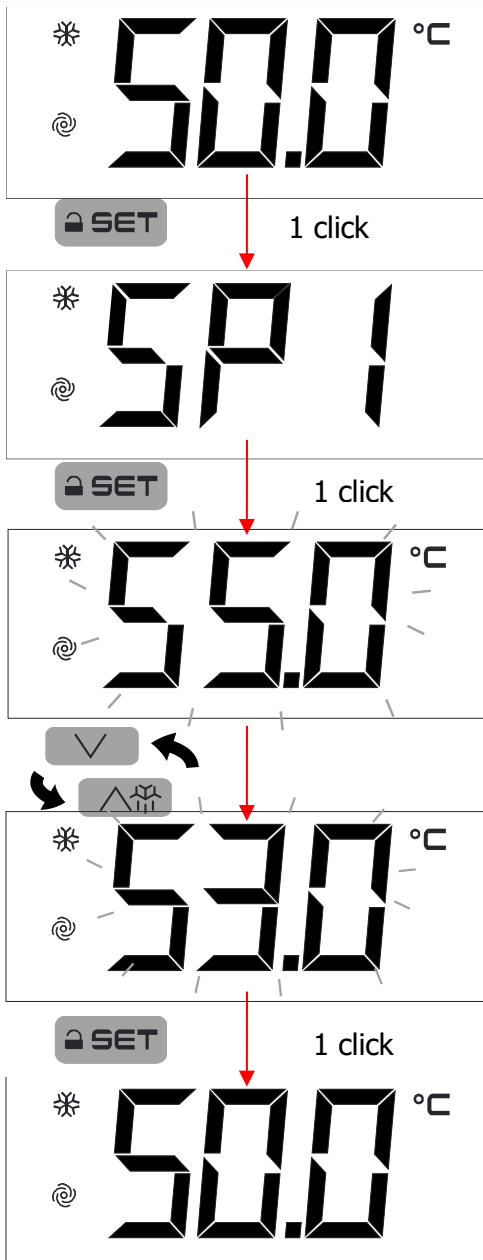

Setting the ECO temperature setpoint

The water temperature set point in ECO mode can be changed with the **SP1** parameter.



Touch  key and select SP1. Touch  to confirm.

The display will show the programmed temperature

Touch  or  to select the desired temperature

Touch  to confirm or  to cancel





10.8. AUTO Mode

It maintains a steady temperature by the heat pump and only use the electrical heater if the temperature falls drastically.

Setting the AUTO temperature setpoint

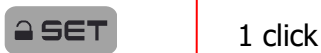
The water temperature set point in AUTO mode can be changed with the **SP2** parameter.



Touch  **SET** key and select SP2. Touch  **SET** to confirm.

The display will show the programmed temperature

Touch  or  to select the desired temperature

Touch  **SET** to confirm or  to cancel



10.9. OVERBOOST Mode

Select this mode to achieve a fast heating by using simultaneously heat pump and electric heater.

This mode Works as a rapid heating. Once the setpoint temperature is reached, the system returns to the initial mode.

- If Overboost mode is switched on when the system Works from **ECO mode**: The system heats the water up to **SP1**, and then returns to ECO again
- If Overboost mode is switched on when the system Works from **Auto mode**: The system heats the water up to **SP2**, and then returns to Auto again

When Overboost mode is active, the display automatically changes showing the water temperature and Obs.

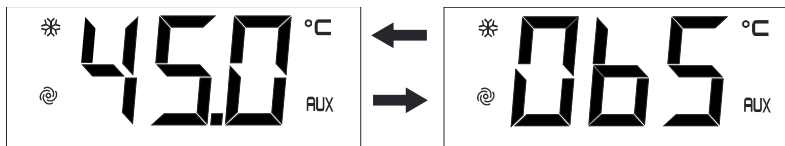

Cancelling the Overboost Mode

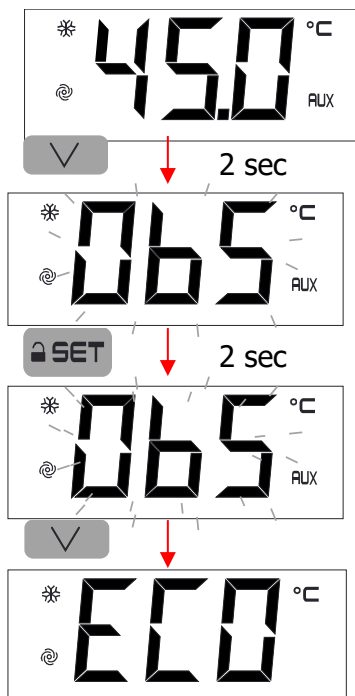

Touch **V** for 2 seconds, **Obs** will blink on the screen

Touch **SET** for 2 seconds again, **Obs** will blink faster

Touch **V** and the mode will be changed for the initial mode.



Parameter SP3 allows to set the minimum temperature that Overboost can be activated.

To change it value, follow the procedure:



1 click



1 click



1 click



Touch and select with and SP3. Touch to confirm

The display will show the programmed temperature

Touch or to select the desired temperature

Touch to confirm or to cancel



10.10. PHOTOVOLTAIC INPUT

Working on this mode, the system automatically heats the water due to electric energy surplus or by Off Peak rate.

The parameters of this mode can only be changed by the Installer's Menu.

Contact with the technician for more information.

The system can be combined with and Photovoltaic Inverter to take advantage of the surplus energy generated by the panels, by forcing the system working and storing this energy in useful hot water.

The system has in the electric boar two terminals to connect a **zero-voltage** contact.



When the contact is closed, the system automatically changes to Photovoltaic mode and the heat pump and electric heater work to achieve the programmed temperature. When the contact is opened, the system returns to the previous mode.

This contact can be also used for Off Peak Rates. To do it, connect into the contact a timer with a **zero-voltage output**.

10.11. Displaying/deleting compressor functioning hours

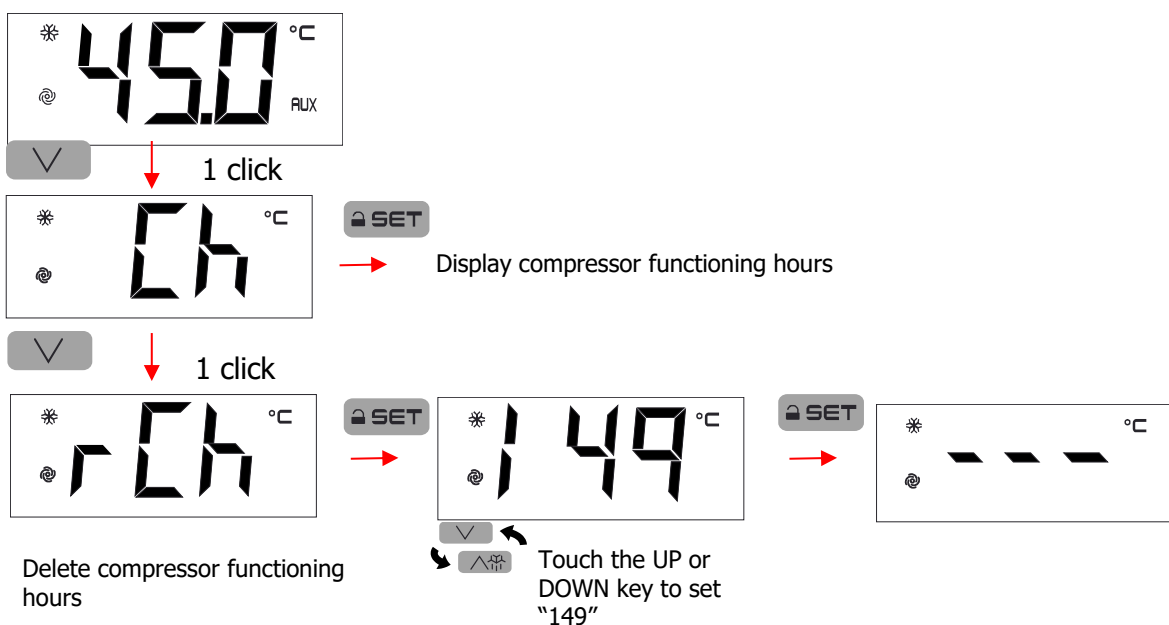



10.12. Antilegionella

The anti-legionella feature reduces the risk of development of bacteria in the tank.

The system performs a thermal shock disinfection to avoid any risk conditions that might cause the development of bacteria. The disinfection is made automatically once a month, reaching a temperature of 62 °C.

Anti-legionella can be disabled or enabled in the installer menu.

10.13. Alarms

Alarms	Meaning
Pr1	Water temperature probe alarm. Check the temperature probe integrity and the electrical connection
Pr2	Water temperature probe alarm. Check the temperature probe integrity and the electrical connection
Pr3	Evaporator temperature probe alarm. Check the temperature probe integrity and the electrical connection
AL	Low temperature alarm
AH	High temperature alarm
LHP	Low pressure switch alarm / Device blocked Switch the device off and on
HP	High pressure switch alarm Switch the device off and on
FiL	Compressor maintenance alarm By touching any key, you delete the compressor functioning hours
UtL	Evaporator failure alarm Switch the device off and on



11. WARRANTY CONDITIONS

Component	Warranty period
Stainless steel tank, Stain steel 2205	5 years
Electrical, electronic and mechanical removable components	2 years
Evaporator panel	5 years

MANUFACTURER WARRANTY CONDITIONS

The warranty exclusively covers productions faults of the product, excluding any liability for any material damage or injury that results directly or indirectly from the use of this product.

The warranty takes effect from the moment that the system is installed, perfectly justified via the commissioning file correctly completed and sent to the factory within 2 months, or in absence of this justification, the date that shall be take into consideration is the invoice date.

The installer or distributor of the product is the solely responsible for compliance with the installation rules given by the manufacturer.

Failures or incidences due to the following reasons are excluded from the warranty:

- Handling or repair the product by unauthorised personnel.
- Damage caused by impact or fall during handling the product after it leaves the factory.
- To exceed the maximum accumulation temperature. The maximum accumulation temperature in all buffer tanks, unless otherwise indicated by Climer Technology, S.L.L., is 85°C. The most restrictive operating temperature range of those indicated in this document, data sheet, equipment manual and identification label will always prevail, contrary indication expressed by Climer Technology, S.L.L
- Damage to the tank, result of malfunction from the overpressure limiting valve. Maximum 3 bars in the secondary, 9 bars in the primary and 9 bars in consumption, and failing that indicated in the identification label of the equipment, applying as maximum pressure of each circuit the most restrictive.
- Location of the product at any place subject to high temperature, humidity, inclemency, frost, aggressive environment...
- Fault caused by an erroneous installation, which makes the product work out of its design conditions.
- Faults caused by not having installed the supplied security group or incorrect installation thereof.
- Overvoltage power supply (grid, beam...)
- Faulty electrical connection, insufficient wire section, non-compliance with electrical schemes...
- Use water within any of the following criteria:
 - o Calcium carbonate (CaCO₃) content > 200 mg / L
 - o > 50 mg / L free carbon dioxide
 - o Alkalinity > 150 mg / L
 - o Water pH less than 6 and greater than 9, measured at 20 °C
 - o > 250 mg / L total of chlorine derivatives chlorides
 - o In general, any condition that exceeds the maximum allowed values
- Fault due to galvanic corrosion result from direct connection of copper pipes without electrolytic sleeve
- Installation of the product in a manner not in accordance with the operating instructions
- Damages result from problems that could not be detectable due to the location of the system (hardly accessible place) and that could have been avoided by a prompt reparation of the product.
- Switch on the heating system without filling the tank (dry heating).
- Any modification of the product without prior agreement with the manufacturer or use spare parts non-authorized or non-supplied by the manufacturer.

Based on these considerations, the warranty comprises in replacing the faulty component to the Installer or Distributor. Transport cost, labour or any compensation are excluded from the warranty.

The fault in single components never comprises the replacing of the product. The installer or distributor is responsible of the changing or reparation of the defective part.

The warranty of the replaced spare part has the same vigour as the product, shall not entail hence the warranty period to be extended or a new warranty period to commence.



CLIMER TECHNOLOGY S.L.L.

This company reserves the right to modify the information contained herein without prior notice.